

Activate.



aspect 



# Activate smart desking.

Back-to-back linear



Introducing Activate workpoints. An economical desking solution with zero compromise on quality or functionality.

Activate is a range of hard-working, all-purpose desk systems that are built to last, and provides a cost-effective answer to the world of flexible, height-adjustable workpoints.

Free-standing linear



True to our 40-year commitment to service excellence, the range incorporates many practical features with a simplified, streamlined design suitable for robust working environments, including:

- Australasian design and manufacture using locally sourced and imported components
- Strong, standardised sub-frames
- Practical, intuitive, user-friendly features
- Easy and fast assembly

Our Activate range features a variety of flexible configurations:

- Free-standing linear
- Back-to-back linear
- Free-standing 120°
- Back-to-back 120° cluster

Activate is backed by our 10-year warranty on all components.

Back-to-back 120° cluster



## Desktop height adjustment

Sit-to-stand height adjustment with 650mm of rise. (low 620mm - high 1270mm)

Controller options range from simple up/down paddles to digital displays and Bluetooth-enabled smartphone app functionality.

Activate is also available as fixed-height desking set at 720mm.

Includes floor levelling glides.



## Simply reliable

Less is often more in hardworking environments, so the sturdy, functional Activate sub-frame is pared back to the essentials. The streamlined and simplified design ensures your office space looks neat and ordered and promotes efficiency.

Every Activate desk is backed by Aspect's dependable, locally based design and engineering. Quality components with European made actuators ensure long-term performance and design that you can trust.



## Cable management

Activate workpoints incorporate superior cable management systems for fully resolved reticulation of power and data cables.

Continuous cable trays have removable covers to conceal unsightly cables.

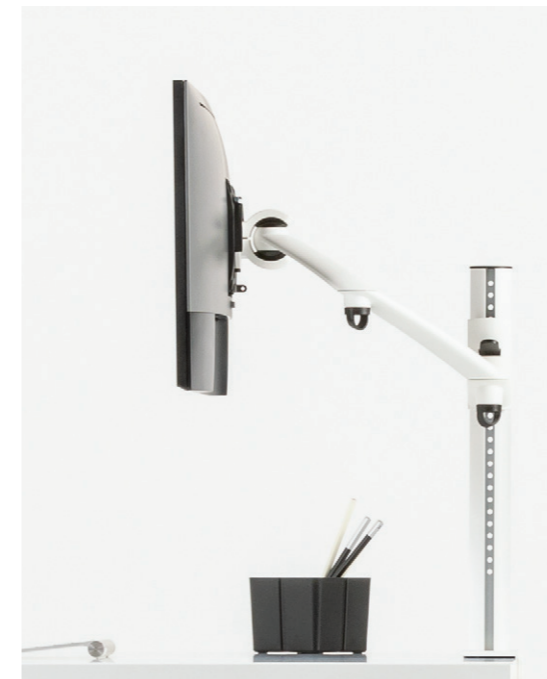

The robust construction and simple design ensure the Activate range will complement any fit-out.

## Design flexibility

Activate is built to withstand repeated relocations, for long-term flexibility of use and adaptability within an evolving workplace.

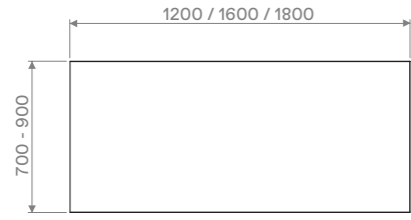

### Free-standing linear

Activate free-standing workpoints are stocked in three desk lengths: 1200, 1600, and 1800mm.

Custom sizes are available on request.

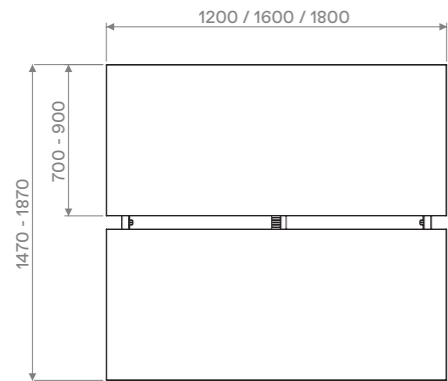
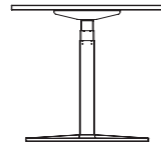

### Back-to-back linear

Activate back-to-back workpoints are stocked in three desk lengths: 1200, 1600, and 1800mm.

Custom sizes are available on request.

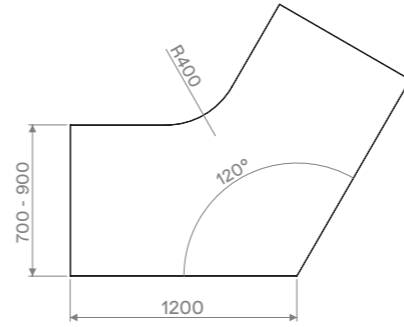
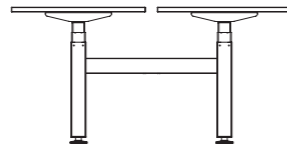
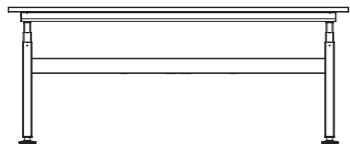

### Free-standing 120°

Activate is available as a 1200 x 1200mm 120° free-standing workpoint.

Custom sizes are available on request.

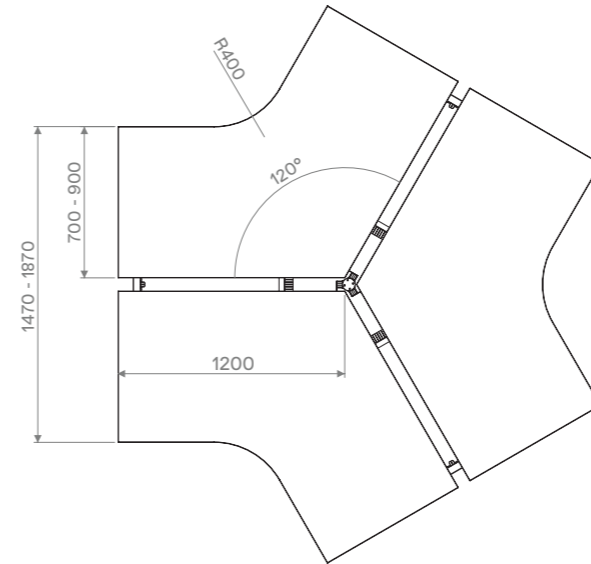
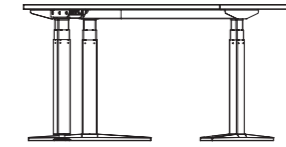
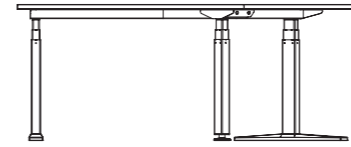

### Back-to-back 120° cluster

Activate is available in a 1200 x 1200mm 120° 'snowflake' cluster layout.

Custom sizes are available on request.

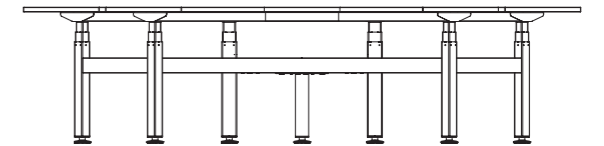
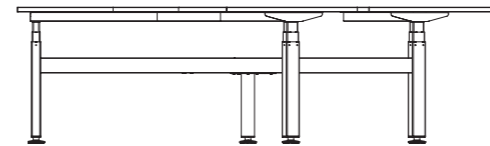

### Desktop finishes

Choose from our wide array of standard laminate finishes. Custom finishes are available on request.

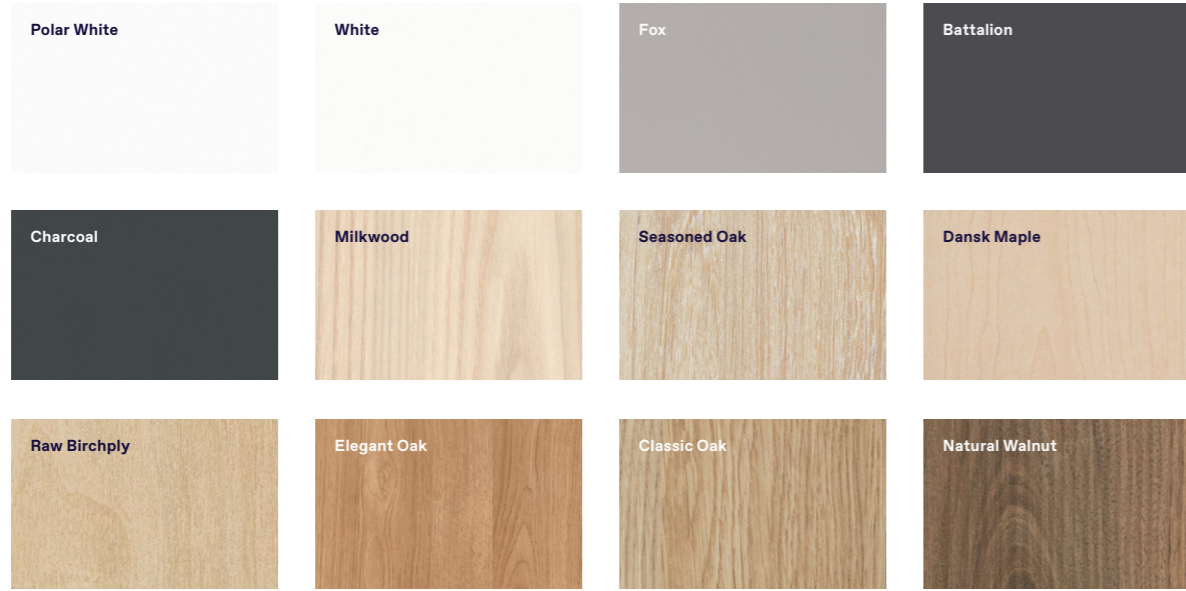

### Sub-frame finishes

Powdercoat finishes are offered in two colours.



### Fluid stacking screens

Fluid stacking screens allow users to personalise their work environment. Stacking panels can be removed and placed by the user anywhere along the fluid rail, without the need for tools.

Stacking screens are produced in a wide range of materials and substrates.

Enjoy all the hallmarks of genuine Aspect design and engineering.

### Strata screens

Strata screens are minimal and contemporary, with full fabric coverage to all faces.

Strata screens can be mounted at a static height from the workpoint sub-frame, or bracketed from the desktop to adjust with the desk height.



### Cable bridge

A continuous cable bridge can be provided to run between clusters so that reticulated cabling is completely concealed and supported. This cable bridge also serves as a connection between back-to-back workpoints.



### Cable sock

The cable sock neatly contains cabling from the cable tray to the underside of individual worktops. A full-length zip provides easy access so that cables can be efficiently loaded and managed. The cable sock is flexible so desks can be adjusted between sitting and standing heights.

# We believe that high-performing spaces enable high-performing people.

**We place a person's comfort and ease-of-use at the heart of every product and system we create. Aspect designers and workplace specialists help you create a complete office furniture solution that will inspire and support people in their work every day.**

Back in 1982, from a small factory in Auckland, Aspect founder and CEO Richard Simmons made his very first furniture prototypes. Driven by a passion for craft and beautiful engineering, he steadily grew the business and is joined today by his three sons and an expert team of designers, engineers and workplace specialists across New Zealand and Australia. Today, Aspect makes collections at the leading edge of international product design, technology, and workplace best practice.

Our focus on crafted, fully resolved commercial furniture means Aspect collections are trusted by some of the largest public and private organisations around Australasia. With nearly 40 years' experience designing and manufacturing collections for the modern workplace, our office furniture has a reputation for being robust, ergonomic, and comfortable throughout the working day.

We make over 70 per cent of our product range in New Zealand and Australia for true control over design, quality, customisation, and lead times. You receive products quickly and reliably from a quality-assured environment. In addition

to speed and flexibility, local manufacturing also creates a smaller environmental footprint.

Our team of product designers and workplace specialists help you define and select a furniture solution to meet your workplace aspirations and project budget using durable and environmentally sound products.

Direct access to our furniture designers means greater flexibility and control over your solution, as we work from our collections, adapt existing products, or design new components.

Aspect Furniture operates ethical and sustainable business practices. We have certification from Good Environmental Choice Australia (GECA) and Environmental Choice New Zealand (ECNZ), and our products are aligned to the Green Star rating tool. Independent certifiers regularly audit our premises under the ISO 9001 and ISO 14001 quality and environmental management systems. Similarly, the health and safety of our employees is vital to our success, and we are certified to the globally recognised AS/NZS 4801 and ISO 45001 occupational health and safety standards.



Furniture, Fittings  
and Flooring  
Licence Number  
3210076







### **Showrooms**

Sydney  
Melbourne  
Canberra  
Auckland  
Wellington  
Christchurch

### **Australia**

1800 696 334  
[infoau@aspectfurniture.com](mailto:infoau@aspectfurniture.com)

### **New Zealand**

0800 323 220  
[info@aspectfurniture.com](mailto:info@aspectfurniture.com)

[aspectfurniture.com](http://aspectfurniture.com)