

OKAMURA

OKAMURA CORPORATION

INTERNATIONAL SALES & MARKETING DIVISION
2-14-27, Akasaka, Minato-ku, Tokyo 107-0052, JAPAN
Tel : +81-3-5561-4085 Fax : +81-3-5561-4086
<http://www.okamura.jp/>

G1A737
2018-05



Sylphy

Office Seating

Instructions for Use

okamura

Safety Instruction (Keep this operation manual)

Symbol indications

Various symbol marks are used in this instruction manual and displayed on the products to show correct and safe usage and to avoid harm to you and others or damage to property. Please understand those before reading the main text of this manual.



User must follow this instruction to prevent from accidents and injuries, or damages to their property.

Caution

● Do not handle roughly, or use improperly.

- Do not use as a carrier.
- Do not stand on the chair or sit on the front side of seat or armrest.



● Do not disassemble or repair on your own. Please contact our official dealers when needed.



● No remodeling. Okamura will have no responsibility for any disadvantage caused by remodeling.

● Gas lift replacement and handling should only be carried out by the trained professional.



● Casters

- For hard floors made of ceramic, stone, tile or wood, use soft casters.
- For soft floors using carpet or rug, use hard casters.



Soft caster



Hard caster

- #### ● Be careful not to get your fingers, hand or clothes caught in the gaps between the moving parts or the back of the pad when adjusting the position of the arm. Also, make sure that the arm are secured tightly before use.

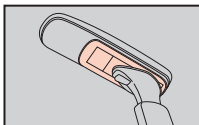
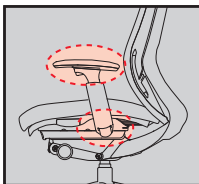

Installation

Please follow instructions below. Failure may cause serious damage to the product.

Indoor use only.



No outdoor or waterfront use.



Avoid direct sunlight.



When placing alongside windows, use curtain or blind to avoid from direct sunlight.



Avoid high temperature, high humidity, or extraordinary aridity.

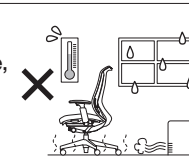

Do not place product under heater or air-conditioner exhausting high temperature air.



Do not place on uneven floor.



For maintenance

● Regular maintenance is for long product life.

● If found unstable due to loose bolts and screws, tighten them.

● For daily care, use a well-wrung soft cloth.

● For stained part, use neutral detergent (1-3%) and completely remove detergent with dry soft cloth.



● For mesh and cushion parts, remove dust by tapping the cloth surface with brush or using vacuum cleaner.

● Cushion cannot be dry-cleaned. Replacing is recommended if exceptionally dirty.



Part names



Adjustable range

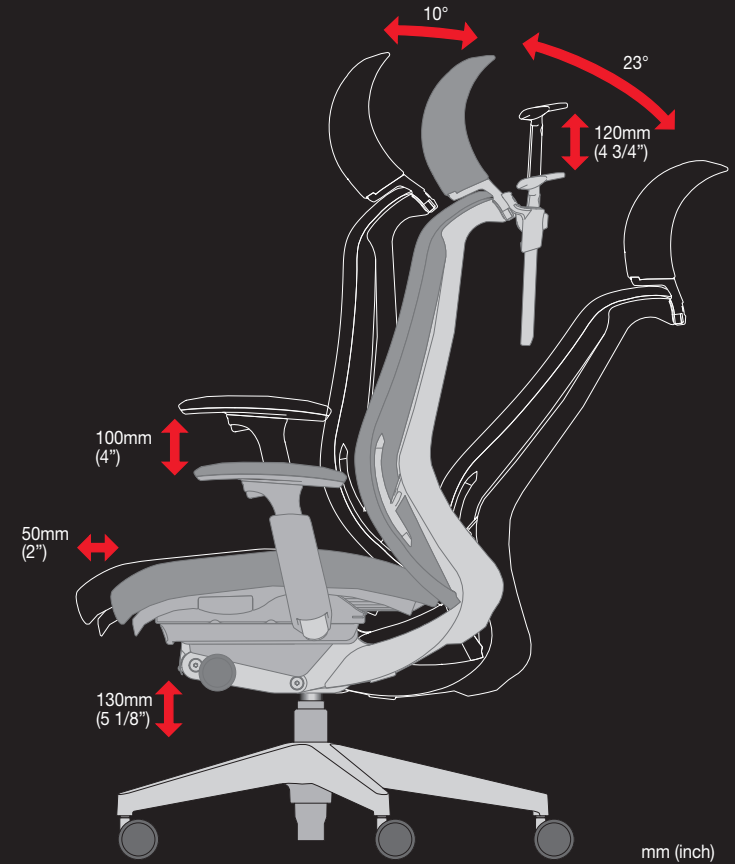

* The headrest, adjustable arms, and hanger are options.

Seat height adjustment

Adjust the seat height using the seat height adjustment lever on the bottom right of the seat. The seat will be lowered if you lift the lever while seated, and it will stop at any position you release the lever at. The seat will be raised if you lift the lever while not seated on the seat.

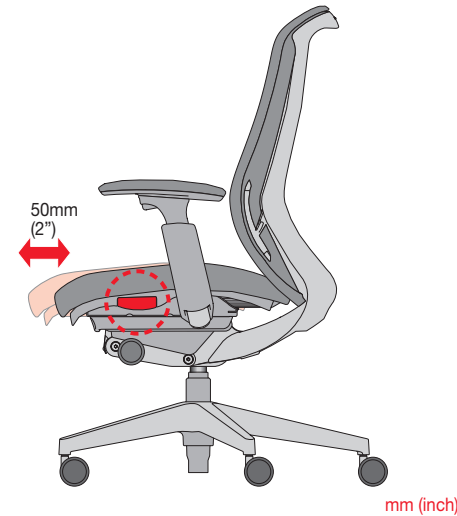
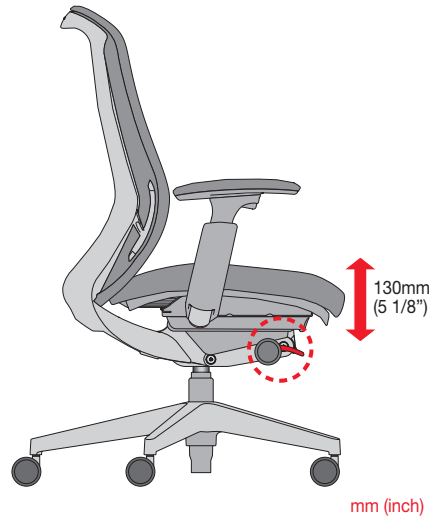
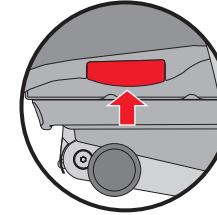
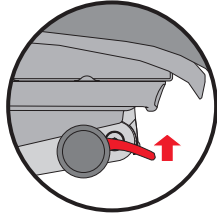

Seat depth adjustment

Adjust the seat depth by sliding the seat forward or back within a range of 50 mm (2") using the Seat slide lever on the bottom left of the seat. This allows for maintaining an appropriate distance between the back and the front edge of the seat, reducing pressure on the back of the knees and providing reliable support for the lower back.

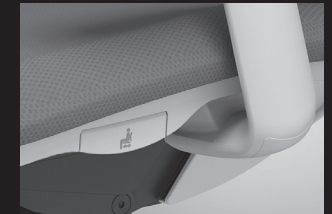

Reclining adjustment

Before adjusting the backrest recline, release the lock by using the reclining lock/release dial on the bottom left of the seat. Set the dial to (B) to recline the backrest. If you want to adjust the backrest recline to the front position, set the dial to (A). In (A), you can also adjust the backrest recline to the back position. To lock the backrest recline, turn the dial clockwise once. After locking the backrest recline, you can release it by turning the dial counterclockwise once, and leaning against the backrest lightly.

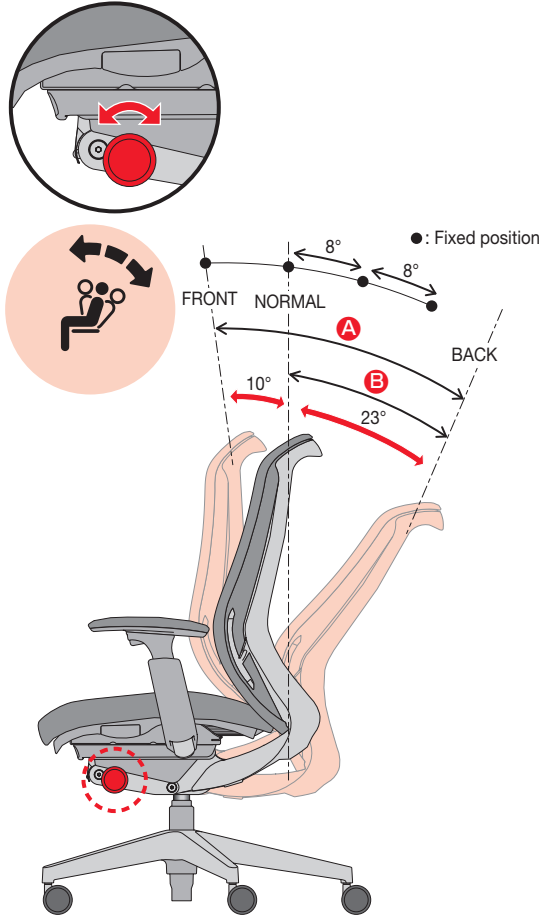
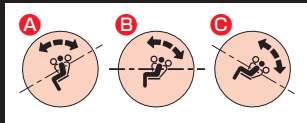

Dial position to lock and release the backrest recline

Turn the reclining lock/release dial to the (A), (B), or (C) position to lock and release the backrest recline.

Backrest recline to the FRONT position

- (1) Turn the dial to (A) to release the lock.
- (2) Move the backrest recline to the FRONT position.
You can also move the backrest recline to the BACK position.
- (3) Turn the dial to (B) to lock the backrest recline.
If you move the backrest recline to the BACK position in step 2, turn the dial to (C) to lock.

* If you want to release the lock again, turn the dial counterclockwise once, and lean against the back lightly.

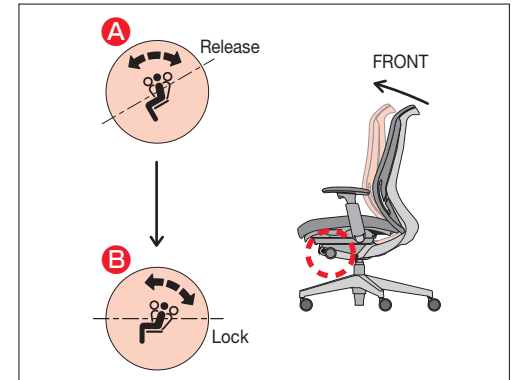

Backrest recline from the FRONT position to the NORMAL position

- (1) Turn the dial to (A) to release the lock.
- (2) Lean against the back to move the backrest recline backward, and turn the dial clockwise once to the (B) position.
- (3) Lift yourself to turn the backrest recline to the NORMAL position.

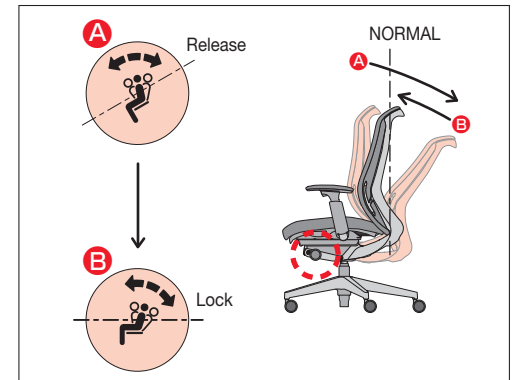

Backrest recline to the BACK position

The backrest recline can be adjusted within a range of 23°.

- (1) Turn the dial to (B) to release the lock.
If the dial is already set to (B), turn it to (A).
- (2) Move the backrest recline to the BACK position.
- (3) Turn the dial to (C) to lock the backrest recline.

* If you want to release the lock again, turn the dial counterclockwise once, and lean against the back lightly.

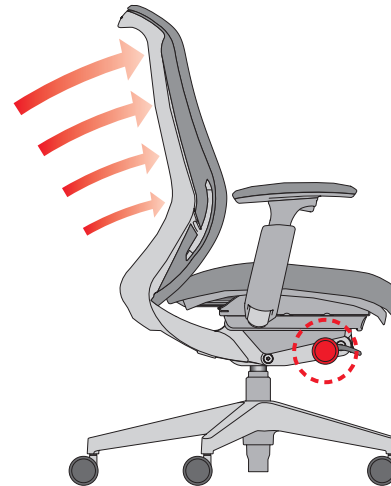
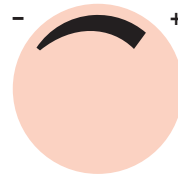
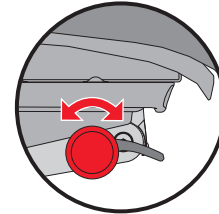
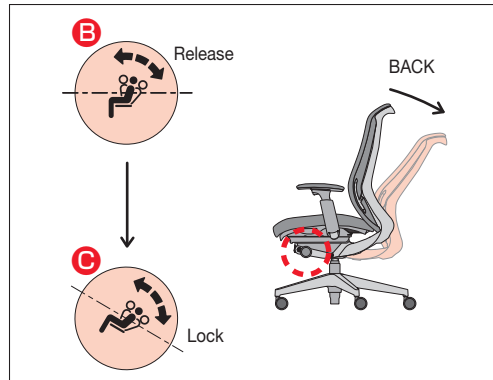

Reclining tension adjustment

Adjust the reclining tension by using the reclining tension adjustment dial on the bottom right of the seat.

The tension to the backrest will be increased if you turn the dial clockwise (+), and the tension will be decreased if you turn the dial counterclockwise (-). Adjust it so that it is comfortable.



Backrest curve adjustment feature

The backrest curve will be loosened (A) if you pull down the levers on both sides of the backrest, and the curve will be tightened (B) if you pull up the levers. Adjust the curve so that your back comfortably fits the backrest.

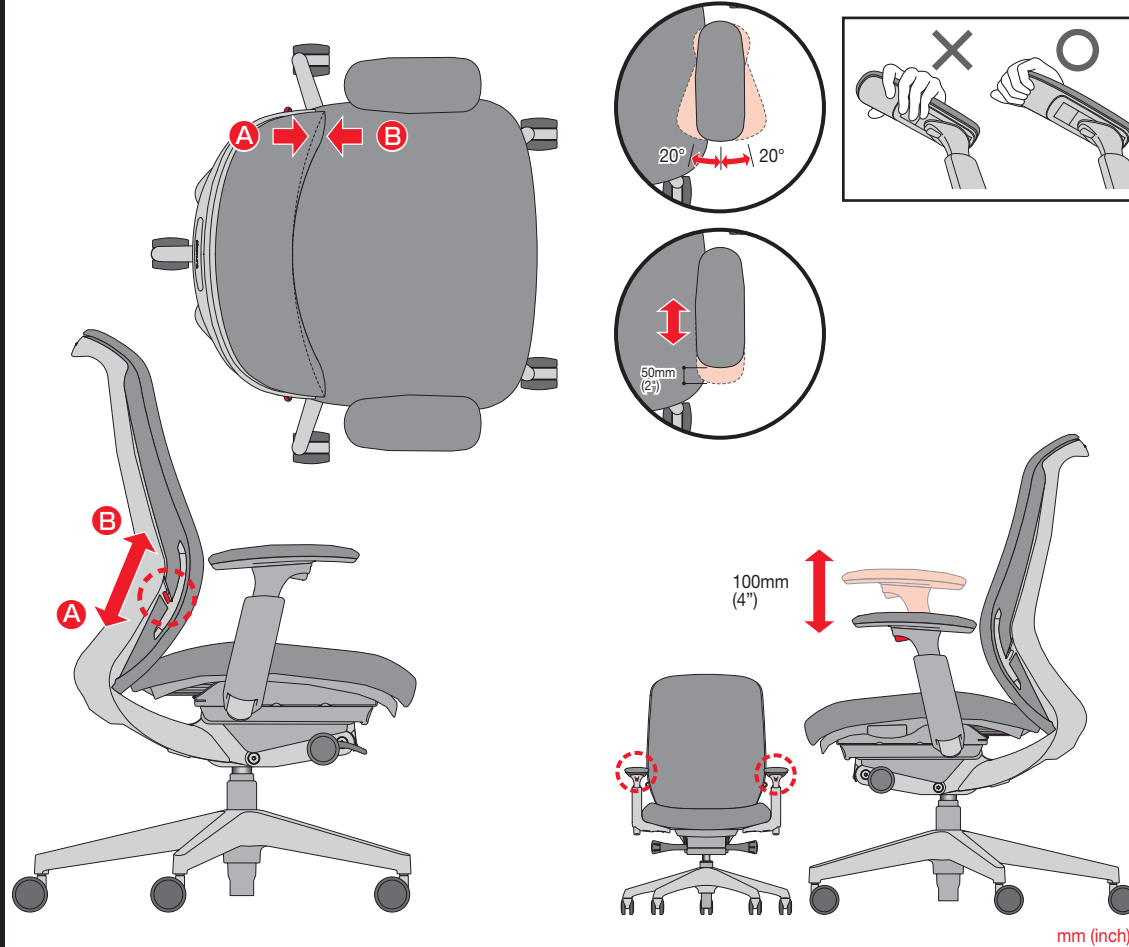
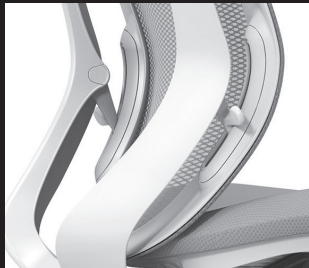

Adjustable arm (option) height adjustment

Release the height lock using the arm height adjustment button on the bottom of the arm pad. The arm height can be adjusted up and down within a range of 100 mm (4") by pushing and holding the button. Lock again by releasing the button. Holding the arm pads and rotating them left and right allows for adjustment of their angles (20° inside, 20° outside). They can also be adjusted forward and back within a range of 50 mm (2").

Notes

- When rotating the adjustable arms, make sure to hold the edge of the arms.
- Before using this product, make sure that the position is securely locked after making the adjustment.



Operation guide

Hanger (option) height adjustment

Adjust the Hanger by pushing the button. The Hanger can be moved up and down within a range of 120 mm (4 3/4"). The Hanger can also be set in a position where it is out of the way when not in use, allowing for a clean appearance.

If you use the Hanger with the low-backrest seat, adjust the Hanger to the highest position.

Note

Before using this product, make sure that the position is securely locked after making the adjustment.

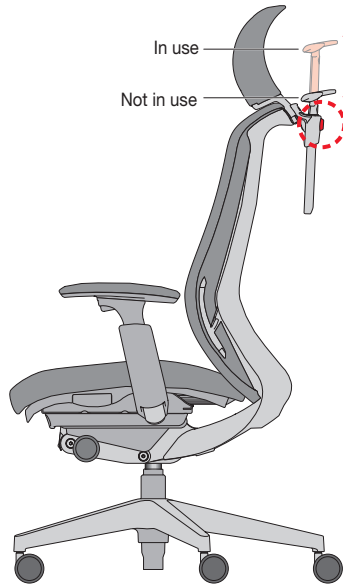
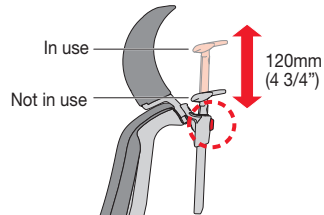
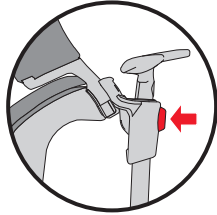

mm (inch)

Part attachment and replacement

Adjustable arm (option)/Design arm (option) attachment and replacement

Attach the arms to the frame arm attachment locations by using hexagon socket bolts (M8 x 25L) and washers.
Tools: 6mm hexagonal wrench (Allen wrench)

Adjustable arm

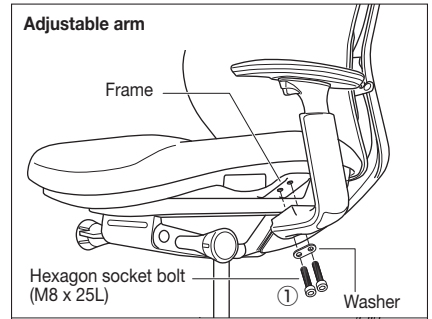

Design arm

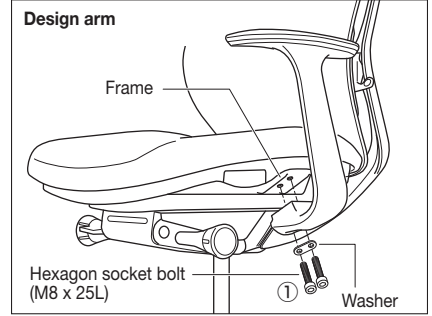

Caster attachment and replacement

Casters are designed as a single unit with shafts and are attached by inserting the shafts.

- (1) Turn the chair upside down.
- (2) Holding the caster, pull the caster strongly to remove.
- (3) Attach a caster by inserting the tip of the caster shaft into the chair leg.
- (4) Push the caster to insert fully.

* If the caster shaft is difficult to insert, use a wooden hammer or other appropriate tool to lightly tap on the caster to insert. If the caster is struck too strongly, it may damage the caster, so exercise caution.

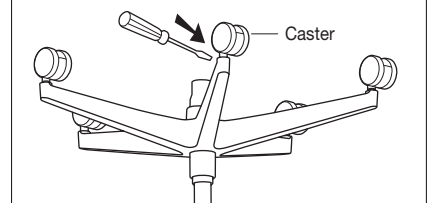

If the caster shaft is difficult to remove, insert a flathead screwdriver between the leg and caster shaft.

Part attachment and replacement

Headrest (option) attachment and replacement

- Attach the Headrest on the backside of the backrest by securing it with hexagon socket bolts (M6 x 25L) and hexagon nuts (M6).
- Attach the cover on the attachment by using the tabs.

* Make sure that the Headrest is secured completely before using.

Tools: 5mm hexagonal wrench (Allen wrench)

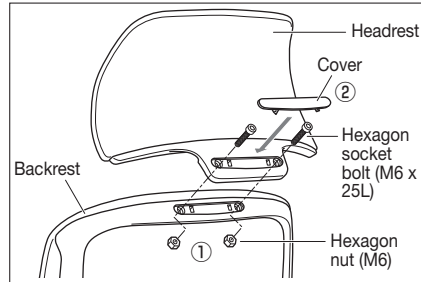

Hanger (option) attachment and replacement

- Attach the Hanger on the backside of the backrest by securing it with hexagon socket bolts (M6 x 20L) and hexagon nuts (M6).
- Attach the cover on the attachment by using the tabs.

* Make sure that the Hanger is secured completely before using.

Tools: 5mm hexagonal wrench (Allen wrench)

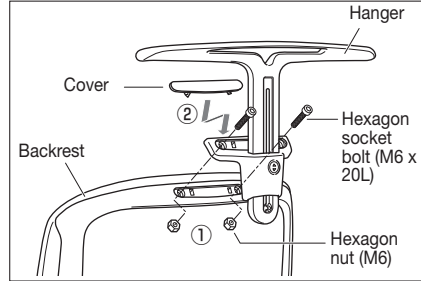

Headrest (option) and Hanger (option) attachment and replacement

The Headrest and Hanger can be attached at the same time as shown in the illustration.

Attach the Headrest first, and then attach the Hanger. Then, attach the cover on the attachment by using the tabs.

* To remove, perform the procedure above in the reverse order.

Make sure that the Headrest and Hanger are secured completely before using.

Tools: 5mm hexagonal wrench (Allen wrench)

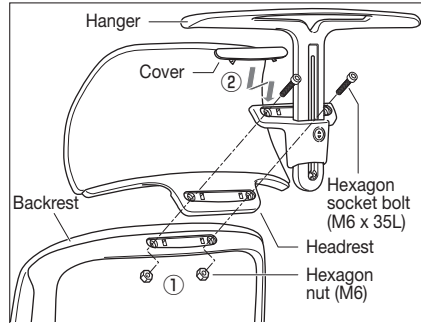

Materials

Part			Materials
Structural parts	Backrest	Frame	Glass-reinforced polyamide >PA-GF<
		Frame for mesh	Polyamide >PA<
		Inner shell for cushion	Polyamide >PA<
	Seat	Inner shell	Polypropylene >PP<
		Frame	Metal (steel)
	Support base		Glass-reinforced polyamide >PA-GF<
			Metal (aluminum) >ADC<
	Legs		Metal (aluminum) >ADC< or Glass-reinforced polyamide >PA-GF<
	Adjustable arm	Pad	Polyurethane >TPU<
		Body	Glass-reinforced polyamide >PA-GF<
Headrest	Inner shell	Polypropylene >PP<	
	Attachment part	Glass-reinforced polyamide >PA-GF<	
Covering material	Mesh	Polyester	
	Cloth	Polyester	
Cushion material	Seat	Polyurethane >PUR<	
	Backrest (Cushion type)	Polyester	
	Headrest	Polyester	

* > XX < indicates the materials of the parts. This information is useful for recycling.

* Please understand that product specifications might change without prior notification due to improvements made to the product.

Troubleshooting

Problem	Check	Solution	Page
The seat cannot be lifted up.	Are you sitting on the seat when adjusting the seat height?	Adjust the seat height while not seated on the seat.	5
	Is the seat height in its highest position?	The seat cannot be lifted up beyond the highest position.	5
The seat cannot be lowered.	Are you sitting on the front edge of the seat?	Sit in the center of the seat while adjusting.	5
	Is the seat height in the lowest position?	The seat cannot be lowered beyond the lowest position.	5
The seat slide lever does not work.	Are you sitting on the seat when adjusting the seat depth?	Adjust the seat depth while not seated on the seat.	6
The backrest does not recline.	The dial on the bottom right of the seat is locked.	Turn the dial counterclockwise, and lean against the backrest.	7-9
	The reclining tension adjustment dial is set to the strong tension (back) position.	Turn the reclining tension adjustment dial to the weak tension (front) position.	10
Casters do not move smoothly.	Are they tangled with lint or wool?	Remove lint or wool or replace the casters.	*
Casters are slippery.	Are you using urethane casters on hard floors such as a plastic tile floor?	Use soft casters.	*
Chair makes noise.	-	Visit a retail shop or the nearest branch.	*

* Please contact an official dealer.